



# Dixie Art Supplies

Since 1935

1-800-783-2612 / 504-733-0668



Dixie Art Main Menu - Click Here

Airbrush Colors Menu

Contact Us

**Free shipping on orders of \$100 or more!**

Select Order Information from Main Menu for more info



## Paasche Talon Airbrush





For hoses and bottles, [go here.](#)  
[back to Paasche Main](#)

### *The NEW Paasche Talon*

Great for T-Shirts, Automotive Art, Helmets and Motorcycles!

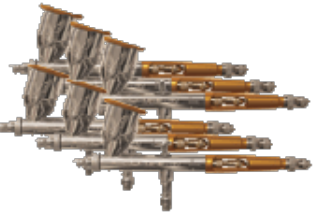
|   |  |                       |
|---|--|-----------------------|
|  | <p><b>99 TG#2L Talon Airbrush<br/>(Airbrush only)</b><br/> <b>list \$126.00, your price \$75.60</b></p> <p>TG Specifications:<br/>           Dual Action Gravity Feed, .38mm Fluid Tip, .4 Ounce Cup with Cover, Hair Lines to 1-1/2 Inch Patterns, Cutaway Handle w/ Pre-set Needle Stop, Crown Cap, New Style Trigger, New Style Piston, New Style Air Valve</p> | <p><b>\$76.60</b></p> |
|  | <p><b>99 TG-SET Talon Airbrush Set</b><br/> <b>list \$157.00, your price \$94.20</b></p> <p>Comes with the Talon Airbrush as described above, 6 foot hose, wrenches and hanger, with .38 and .66 heads.</p>  | <p><b>\$94.20</b></p> |
|  | <p><b>99 TG-3F SET Talon Airbrush Set list</b></p>   |                       |

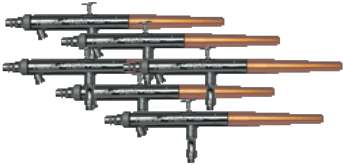
|  |  |                        |
|--|--|------------------------|
|    | <p><b>\$189.00, your price \$113.40</b><br/>Comes with the Talon Airbrush as described above, 6 foot hose, wrenches and hanger, with .25, .38 and .66 heads, and NEW fan air cap.</p>  | <p><b>\$113.40</b></p> |
|   | <p><b>99 TG-6P Talon 6-Pack, no hoses</b><br/><b>list \$675.00, your price \$405.00</b></p>  | <p><b>\$405.00</b></p> |
|   | <p><b>99 TS#3L Talon Syphon Feed</b><br/><b>list price \$94.00, YOUR PRICE: \$56.40</b><br/>TS Double Action Airbrush only with .66mm Head. No accessories.</p>  | <p><b>\$56.40</b></p>  |
|   | <p><b>99 TSSET Talon Syphon Airbrush Set</b><br/><b>list price \$131.00, your price \$78.60</b><br/>TS#3 Double-Action Syphon Airbrush w/A-1/8-6 6' Air Hose w/Couplings, VL-1/4-OZ Metal Color Cup (1/4oz/7cc), VL-1-OZ Bottle Assembly (1oz/29cc), H-194 Bottle, Cap/Gasket (1oz/29cc), TT-2 Tip (.38mm), TN-2 Needle (.38mm), TA-2 Aircap (.38mm), A-34 Hanger, TAL-35 Allen Wrench, TAL-28 Wrench, TTALB "22 Airbrush Lessons" Booklet</p> | <p><b>\$78.60</b></p>  |
|  | <p><b>99 TS6P Talon Siphon Feed Airbrush 6-Pack, no hoses or bottles.</b><br/><b>list price \$564.00 your price \$338.40</b></p>   | <p><b>\$338.40</b></p> |

[Click here for Bottles \(for the Talon TS\)](#)

## Paasche Talon Parts

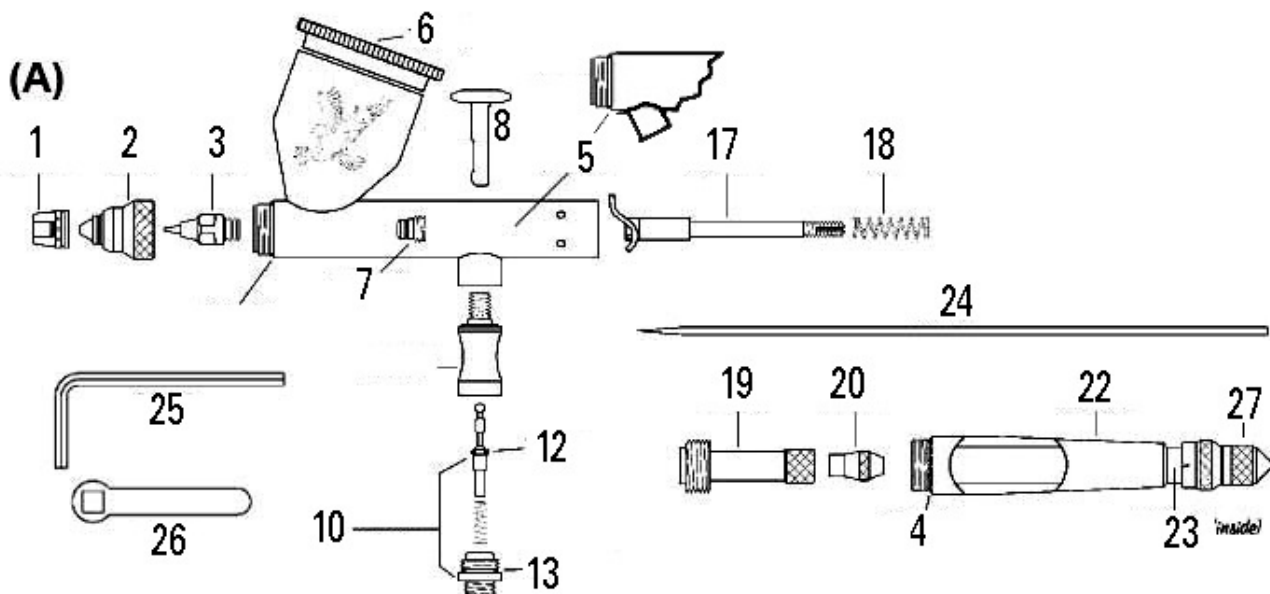

| No. | <a href="#">Click here</a> | Description | list price | Your price |
|-----|----------------------------|-------------|------------|------------|
|-----|----------------------------|-------------|------------|------------|

|    |               |   |                    |              |
|----|---------------|---|--------------------|--------------|
| 1  | X-41 \$4.29   | Needle Cap (stock TS)                                     | <del>\$5.95</del>  | <b>4.29</b>  |
|    | TAL-23 \$4.29 | Needle Cap (crown cap)<br>(stock TG / optional TS)        | <del>\$5.95</del>  | <b>4.29</b>  |
| 1A | TAF-3 \$8.75  | Fan Aircap (use w/.66mm tip/needle)<br>(optional TG & TS) | <del>\$12.50</del> | <b>8.75</b>  |
| 2  | TA-1 \$4.99   | Aircap .25 mm (optional TG)                               | <del>\$7.50</del>  | <b>4.99</b>  |
|    | TA-2 \$4.99   | Aircap .38 mm (stock TG & TS)                             | <del>\$7.50</del>  | <b>4.99</b>  |
|    | TA-3 \$4.99   | Aircap .66 mm optional TG & TS                            | <del>\$7.50</del>  | <b>4.99</b>  |
| 3  | TT-1 \$5.65   | Nozzle .25mm Tip (optional TG)                            | <del>\$8.50</del>  | <b>5.65</b>  |
|    | TT-2 \$5.65   | Nozzle .38mm Tip (stock TG & TS)                          | <del>\$8.50</del>  | <b>5.65</b>  |
|    | TT-3 \$5.65   | Nozzle .66mm Tip (optional TG & TS)                       | <del>\$8.50</del>  | <b>5.65</b>  |
| 4  | MIL-12 \$0.85 | O-Ring for TG/TS body or handle                           | <del>\$1.10</del>  | <b>0.79</b>  |
| 5  | TG-30 \$32.95 | Shell Assembly (TG body)                                  | <del>\$46.00</del> | <b>32.95</b> |
| 5  | TS-30 \$32.95 | Shell Assembly (TS body)                                  | <del>\$46.00</del> | <b>32.95</b> |
| 6  | TG-4 \$3.25   | Cup Cover   | <del>\$4.50</del>  | <b>3.25</b>  |
| 7  | TAL-8 \$4.29  | Packing Assembly  | <del>\$5.95</del>  | <b>4.29</b>  |
| 8  | TAL-37 \$4.69 | Trigger Assembly  | <del>\$6.50</del>  | <b>4.69</b>  |
| 9  | TAL-14 \$4.29 | Valve Casing  | <del>\$5.95</del>  | <b>4.29</b>  |
| 10 | TAL-32 \$5.75 | Air Valve Assembly  | <del>\$7.95</del>  | <b>5.75</b>  |
| 12 | TAL-26 \$1.05 | O Ring (air piston)                                       | <del>\$1.45</del>  | <b>1.05</b>  |
| 13 | TAL-22 \$3.05 | O Ring (air valve)  | <del>\$4.25</del>  | <b>3.05</b>  |
| 17 | TAL-18 \$6.69 | Rocker Assembly   | <del>\$7.90</del>  | <b>6.69</b>  |
| 18 | MIL-11 \$1.15 | Needle Spring   | <del>\$1.60</del>  | <b>1.15</b>  |

|     |                |                                  |                    |              |
|-----|----------------|----------------------------------|--------------------|--------------|
| 19  | TAL-17 \$3.60  | Spring Housing                   | <del>\$5.00</del>  | <b>3.60</b>  |
| 20  | TAL-19 \$2.85  | Needle Locknut                   | <del>\$3.95</del>  | <b>2.85</b>  |
| 22  | TAL-34 \$11.15 | Handle & Stop TG                 | <del>\$15.50</del> | <b>11.15</b> |
| 22A | TAL-34 \$4.99  | Handle , Aluminum TS             | <del>\$7.50</del>  | <b>4.99</b>  |
| 23  | 3A-4 \$3.05    | Rubber "O" Ring (pack of 6)      | <del>\$4.25</del>  | <b>3.05</b>  |
| 24  | TN-1 \$4.99    | Needle .25 mm (optional TG)      | <del>\$7.50</del>  | <b>4.99</b>  |
|     | TN-2 \$4.99    | Needle .38 mm (stock TG & TS)    | <del>\$7.50</del>  | <b>4.99</b>  |
|     | TN-3 \$4.99    | Needle .66 mm (optional TG & TS) | <del>\$7.50</del>  | <b>4.99</b>  |
| 25  | TAL-35 \$1.45  | Allen Wrench for Talon           | <del>\$2.00</del>  | <b>1.45</b>  |
| 26  | TAL-28 \$1.45  | Wrench for Talon                 | <del>\$2.00</del>  | <b>1.45</b>  |
| 27  | TAL-33 \$5.00  | Needle Stop (for TG handle)      | <del>\$6.95</del>  | <b>5.00</b>  |

Some products are sent directly from the manufacturer. Shipping times vary. If expedited shipping is needed, please mention in the customer comments or call 1-800-783-2612

**e-mail us: [click here](#)**

**Airbrush Home** [Quick Index](#) [Bottles, Hoses, Parts](#) [Compressors](#)  
[Order Information](#) [Our Catalog](#) [Review Order](#) [Index](#)  
Dixie Art Supplies • 5440 Mounes St., Suite 108 • New Orleans, LA • 70123  
1-800-783-261